

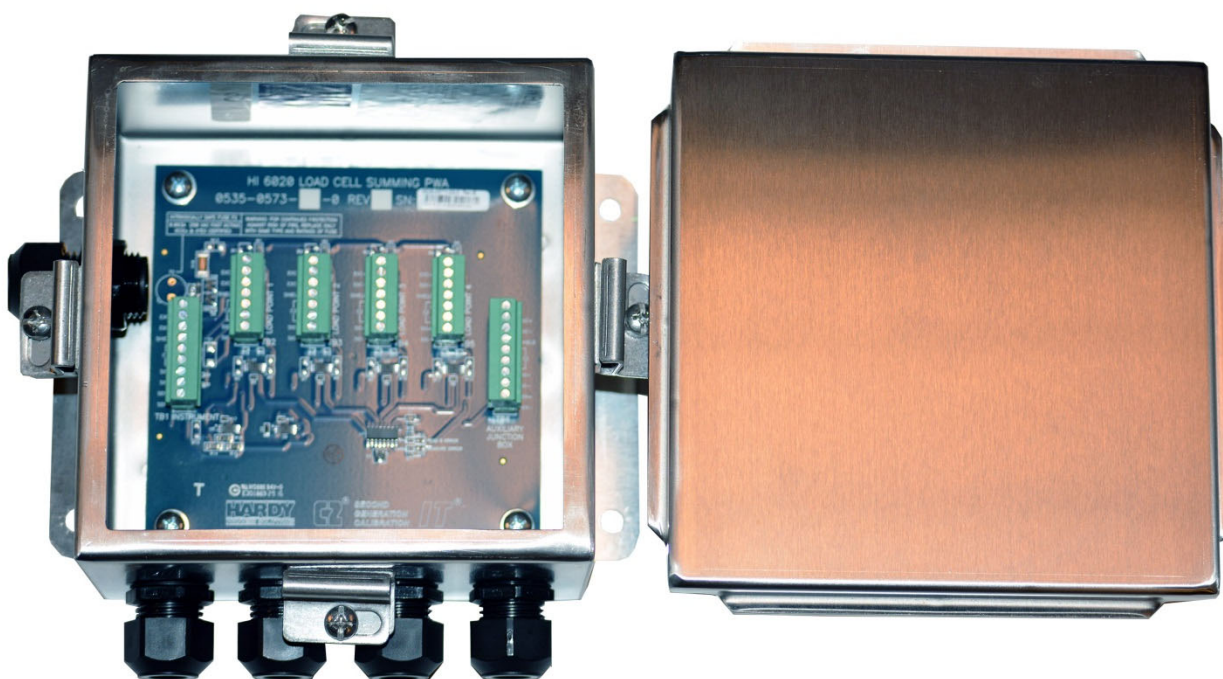



HI 6020IT and HI 6020JB



US & Canada Hazardous Locations User Guide (Class I, II, III, Division 1, Class I, Zone 0 and Zone 20)



Hardy Process Solutions Document Number: 0596-0352-01 REV C

CONTROLLED DOCUMENT
CHANGES MAY NOT BE MADE
WITHOUT APPROVAL FROM
CERTIFICATION AGENCY

	 WARNING!
	DO NOT INSTALL OR PERFORM ANY SERVICE ON THIS EQUIPMENT BEFORE THE AREA IN WHICH THE HI 6020 JB OR IT SUMMING BOX IS LOCATED HAS BEEN SECURED AS NON-HAZARDOUS BY PERSONNEL AUTHORIZED TO DO SO BY THE RESPONSIBLE PERSON AT THE CUSTOMER'S SITE

	 WARNING!
	INSTALLATION SHOULD BE IN ACCORDANCE WITH ANSI/ISA RP12.06.01 "INSTALLATION OF INTRINSICALLY SAFE SYSTEM FOR HAZARDOUS (CLASSIFIED) LOCATIONS" AND THE ELECTRICAL SAFETY CODE (ANSI/NFA 70) ARTICLE 504. WHEN THIS SUMMING BOX IS INCLUDED AS A COMPONENT PART OF A SYSTEM, THE RESULTING DESIGN MUST BE REVIEWED BY QUALIFIED PERSONNEL WHO ARE FAMILIAR WITH THE CONSTRUCTION AND OPERATION OF ALL COMPONENTS IN THE SYSTEM AND THE POTENTIAL HAZARDS INVOLVED. FAILURE TO OBSERVE THIS PRECAUTION COULD RESULT IN BODILY HARM AND/OR PROPERTY DAMAGE.

	 WARNING!
	ALL EQUIPMENT MUST BE INSTALLED IN ACCORDANCE WITH THE INSTALLATION INSTRUCTIONS DETAILED IN THIS USER GUIDE. INCORRECT OR SUBSTITUTE COMPONENTS AND/OR DEVIATION FROM THESE INSTRUCTIONS CAN IMPAIR THE INSTRINSIC SAFETY OF THE DEVICE AND COULD RESULT IN BODILY INJURY AND/OR PROPERTY DAMAGE.

	 WARNING!
	TO PREVENT IGNITION OF FLAMMABLE OR COMBUSTIBLE ATMOSPHERES, DISCONNECT POWER BEFORE SERVICING

	 WARNING!
	FOR CONTINUED PROTECTION AGAINST SHOCK HAZARD, CONNECT TO THE INTRINSICALLY SAFE GROUND ONLY. DO NOT REMOVE THE GROUNDING CONNECTION.

 CAUTION
OBSERVE PRECAUTIONS FOR HANDLING ELECTROSTATIC SENSITIVE DEVICES.

Contents



- Contents 3
- Chapter 1 4
- HI 6020IT and HI 6020JB Overview 4
 - Introduction to the HI 6020IT and HI 6020JB Summing Boxes 4
- Chapter 2 5
- Specifications and Features 5
 - Basic Specifications 5
 - HI 6020IT and HI 6020JB 5
 - Approvals 7
 - Features and Capabilities 7
 - Hardy Process Toolbox 7
 - C2® and Calibration 7
 - INTEGRATED TECHNICIAN® 7
- Chapter 3 8
- Installation of Intrinsically Safe HI 6020 IT and HI 6020JB Summing Boxes into Hazardous (Classified) Locations 8
 - Wiring Summing Boxes 8
 - Connecting to Hardy Summing Boxes or Summing Cards 9
 - Connecting Load Cell Sensors to a Hardy Summing Box 10
 - Applicable Certification Documents for Intrinsically Safe Protection Techniques 11
 - Standards used for evaluation of the HI 6020 summing box series: 11

Chapter 1

HI 6020IT and HI 6020JB Overview



This user guide describes installation, setup and operating procedures for the HI 6020IT and HI 6020JB summing boxes. Be sure to read and understand all cautions, warnings, and safety procedures in this user guide to ensure safe installation and operation of the summing boxes.

Hardy Process Solutions sincerely appreciates your business. We encourage input about the performance and operation of our products from our customers. Should you not understand any information in this user guide or experience any problems with this product, please contact our Technical Support Department at:

Phone: (858) 278-2900

Toll Free: 1-800-821-5831

FAX: (858) 278-6700

E-Mail: hardysupport@hardysolutions.com or hardyinfo@hardysolutions.com

Website: www.hardysolutions.com

Please visit our website for the latest revision of this User Guide and sign up for the Hardy Newsletter to get the latest information on all Hardy products and services. For answers to technical issues and service problems, please visit the Hardy WebTech section of our website or contact a technician by phone during our normal operating hours (6:30 AM to 5:30 PM Pacific Time).

Introduction to the HI 6020IT and HI 6020JB Summing Boxes

The Hardy HI 6020 summing box is a critical component in a weighing system that enables use of Hardy's core technologies - C2[®] electronic calibration and Integrated Technician[®] (IT).

Each summing box distributes excitation voltage to up to four load cells and transfers each load cell's performance characteristics and weight signals to the Hardy weighing instrument. A summing card with IT allows a weighing instrument operator to switch to the summing card's internal test circuit and diagnose the entire weighing system from the front panel of the instrument or a remote location over the Internet. Individual load cells can be isolated from each other for weight and voltage readings, allowing a technician or operator to quickly and safely troubleshoot weighing system faults and anomalies.

The HI 6020 Summing box is available with a variety of options, including Integrated Technician[®] (IT) and trim pots (for non-Hardy load cells). The UL Type 4/4X stainless steel enclosure features a thick-wall design with an interior seal for a long lasting, robust wash-down installation. Two configurations are available, a 5-hole version for connecting up to four load cells to a Hardy weight indicator, controller, or module; or a 6-hole version that connects to a second HI 6020 summing box to enable up to eight load cells to be connected to a Hardy weight indicator or controller. The HI 6020 summing box comes with four packaged hole-plugs, six cable grip fittings, suitable for load cell cables with an outside diameter of 4.3mm to 11.4mm.

Chapter 2

Specifications and Features



Chapter 2 provides specifications for HI 6020 Summing Box series instruments. The specifications listed are designed to assist in the installation, operation and troubleshooting of your summing box. All service personnel should be familiar with this section before installing or repairing the instrument.

Basic Specifications

There are two main configurations for the HI 6020 summing box.

1. The HI 6020JB which includes a summing board without INTEGRATED TECHNICIAN® (IT)
2. The HI 6020IT which includes a summing board with INTEGRATED TECHNICIAN® (IT)

The HI 6020JB-SSX-Y provide different options.

Where:

SS: stainless steel enclosure

X: **X= 1** without trim pots or
X= 2 with trim pots

Y: **Y = blank** is a 5-hole summing box enclosure

Y = 6 is a 6-hole summing box enclosure enabling connection to a second summing box

The HI 6020JB and HI 6020IT is provided with cable glands and has approval for use in the following hazardous areas:

Class I, Division 1, Groups A, B, C, D, T4

Class II, Division 1, Groups E, F, G, T4

Class III, Division 1, T4

Class I, Zone 0, Group IIC, T4

Class II, Zone 20, Group IIIC, T4

Class I, Division 2, Groups A, B, C, D, T5

Class II, Division 2, Groups F, G, T5

Class III, Division 2, T5

IMPORTANT NOTE:

Only the stainless steel versions of the HI 6020JB and HI 6020IT junction boxes are certified for use in hazardous areas.

HI 6020IT and HI 6020JB

Number of Load Cells Supported

8 (requires two summing boxes, one 6-hole summing box and one 5-hole summing box)

4 (requires only one 5-hole summing box)

Enclosure

Stainless Steel

PCB Dimensions

4.88" (12.38 cm) x 4.88" (12.38 cm)

Connector Type

- Removable Plug-In Terminal Blocks
- 4 off, 7 pin, 1 row, 3.5 mm pitch (load points)
- 2 off, 9 pin, 1 row, 3.5 mm pitch (instrument and auxiliary ports)

Temp Range

-10 to +60°C (14 to 140°F)

Maximum Excitation Voltage and estimated Excitation Current

The maximum excitation voltage, on the summing box side of the IS barrier, is 5VDC.

The maximum excitation current is 70mA under normal operating conditions, and is limited to 100mA by the selected IS barriers.

The required IS barrier supply voltage and actual excitation current drawn for a load cell weighing system, depends upon the IS barriers selected, the load cell resistance, the cable length between the excitation voltage source and the summing box, the number of summing boxes, and the number of load cells required for the weighing system.

Please review the installation section for additional information.

Trim Pot Number of Turns

11 (for use with non-C2 systems)

Trim Pot Impedance Range

0-10 Ω

Power Rating

Non Hazardous, Safe area Locations,

Class I and II, Division 2 Hazardous and Class III Division 1 and 2 Hazardous (Classified) Locations, and

Class I, Zone 0 and 2 Groups IIC, Zone 20 and 22 Groups IIIC

HI 6020IT: 5 VDC, Class 2 source, max. 50 mA

HI 6020JB: 2-15 VDC, Class 2 source, max. 275 mA

Class I and II, Division 1 Hazardous (Classified) Locations and Class I, Zone 0 and 2 Groups IIC, Zone 20 and 22 Groups IIIC

Power must be supplied to the summing box through approved intrinsically safe barriers per control drawing 0594-0007 (HI 6020JB) or 0594-0008 (HI 6020IT)

HI 6020IT: 5 VDC, Class 2, max. 50 mA

HI 6020JB: 5 VDC, Class 2, max. 50 mA

Warranty

Two-year warranty against defects in workmanship

Housing Torque Specification

Enclosure Bolt Torque Specification: 50-55 in/lb

Additional Instruction: Be sure to lubricate (oil) the screw threads to prevent galling of the screw and enclosure screw flange threads.

Approvals

- CE
- UL, CUL (ordinary location)
- Class I, Division 1, Groups A, B, C, D, T4
- Class II, Division 1, Groups E, F, G, T4
- Class III, Division 1, T4
- Class I, Zone 0, Group IIC, T4
- Class II, Zone 20, Group IIIC, T4
- Class I, Division 2, Groups A, B, C, D, T5
- Class II, Division 2, Groups F, G, T5
- Class III, Division 2, T5

See control drawing 0594-0007 (HI 6020JB) or 0594-0008 (HI 6020IT) for specific installation instructions

Features and Capabilities

Hardy Process Toolbox

The Hardy Process Toolbox is a set of productivity tools that support process weighing functions. Each tool in the Hardy Process Toolbox saves time, increases accuracy, improves efficiency or reduces risk in process weighing applications.

C2® and Calibration

Traditional calibration uses certified test weights. C2® Electronic Calibration allows a scale to be calibrated without the need for test weights. A C2 weighing system consists of up to eight load cell sensors per HI 6020 IT or JB summing box, C2 interconnect cable, and a Hardy instrument, controller, or module with C2.

Each Hardy Process Solutions C2-certified load sensor outputs digital information used for calculating the calibration. When Hardy instrument reads the signals from the load sensors, it calibrates the scale based on the load sensor's output plus a user-supplied reference point value (from 0 to any known weight on the scale).

NOTE: Check the Hardy instrument, controller, or module to verify the number of load sensors that can be supported.

INTEGRATED TECHNICIAN®

The HI 6020IT features INTEGRATED TECHNICIAN® (IT), a system diagnostics program that makes it possible to diagnose weighing system problems from a Hardy Instrument, controller, or module that reads individual load sensor voltages and weights and isolates individual system components for quick and easy troubleshooting.

NOTE: C2 and INTEGRATED TECHNICIAN are registered trademarks of Hardy Process Solutions.

Chapter 3

Installation of Intrinsically Safe HI 6020 IT and HI 6020JB Summing Boxes into Hazardous (Classified) Locations



This user guide is intended to provide the user with an overview regarding the proper selection of electronic weighing systems used in hazardous locations. This document does not provide details on the installation of equipment as this is typically the responsibility of the installing electrician and/ or engineering design firm.

For the latest information please refer to the appropriate set of control drawings which will be one of the items shipped with the summing box.

- HI 6020JB series please refer to **control drawing 0594-0007**
- HI 6020IT series please refer to **control drawing 0594-0008**

Additional copies of this user guide and control drawings are available on the Hardy website at:

<http://www.hardysolutions.com/products/load-cells--platform-scales/accessories/product/511/hi-6020it-and-hi-6020jb-junction-boxes>

Wiring Summing Boxes

IMPORTANT NOTES when wiring between load cells, summing boxes, and intrinsically safe barriers

1. Associated apparatus manufacturer's installation drawing must be followed when installing this equipment.
2. Resistance between Intrinsically Safe Ground and earth ground must be less than 1.0 Ohm.
3. Install Intrinsic Safe Barriers in accordance with barrier instructions.
4. The total combined length of all wiring in the system, including the cable from each associated apparatus to and from the summing box, and to each load cell must not exceed 300 feet.
 - a. Installation should be in accordance with any applicable local electrical code, which may include ANSI/ISA RP12.06.01 "Installation of Intrinsically Safe System for Hazardous (Classified) Locations," the electrical Safety code (ANSI/NFPA 70) Article 504.
 - b. The products for use in both Class I, II, III Division 1 and 2 areas (NEC 501, 502) and Class 1, Zone 0 and 2, Group IIC, and Zone 20 and 22, Group IIIC areas (NEC 505, 506) is the HI 6020JB-SSX-Y and the HI 6020IT-SSX-Y (both shipped with cable glands):
 - c. SS = Stainless Steel enclosure
 - d. 1 = Without trim pots, 2 = With Trim Pots
 - e. Y= blank is a 5-hole summing box enclosure, and Y=6 is a 6-hole summing box enclosure enabling connection to a second summing box
5. SB (summing box) maximum cable length 250 ft; used between the summing box and IS barriers.
6. Substitution of components may impair Intrinsic Safety and/or void Hazardous Area Approval.

WARNING: To prevent ignition of flammable or combustible atmospheres, disconnect power before servicing

AVERTISSEMENT: Veuillez débrancher l'appareil avant toute manipulation afin d'éviter tout amorçage de combustibles ou d'une zone inflammable.

Connecting to Hardy Summing Boxes or Summing Cards

To connect more than one load cell to a Hardy instrument, controller, or module, you will need a summing card or summing box to aggregate the signals to provide a singular weight reading. While a platform, bench or floor scale has a built in summing card to perform this function, load cells need an external Summing Card or Summing box.

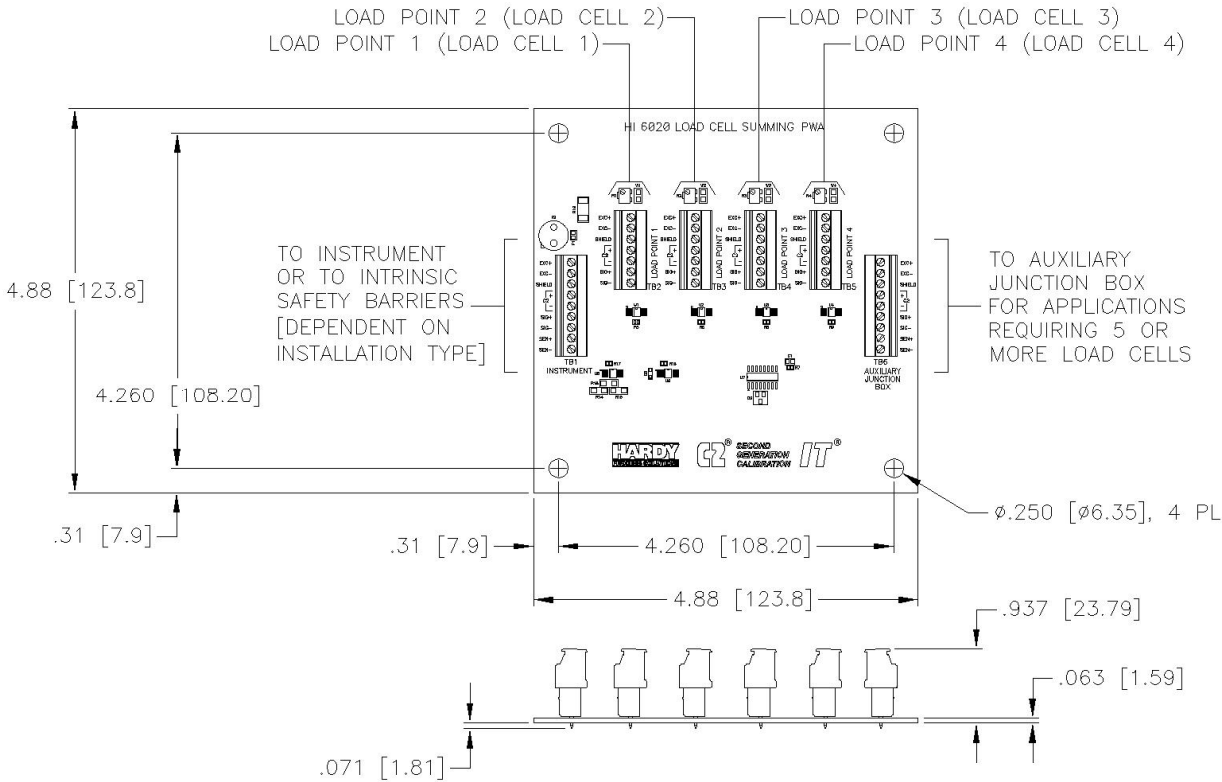

HI 6020 IT Summing Box Wiring Diagram

To connect more than four load sensors to a single Hardy instrument, controller, or module two summing boxes will need to be cascaded by connecting the instrument output from a 5 hole version of the HI 6020 summing box to the auxiliary summing box input connector on a 6-hole version of the HI 6020 summing box.

Connecting Load Cell Sensors to a Hardy Summing Box

The diagrams below show Hardy Load Sensors with C2 and non-Hardy Load Cells (4 wire and 6 wire are similar except 6 wire adds sense wiring) that do not have C2. Wire the terminal connector that plugs into the front of the Weight Processor Modules by carefully following the Weigh Scale Input termination label.

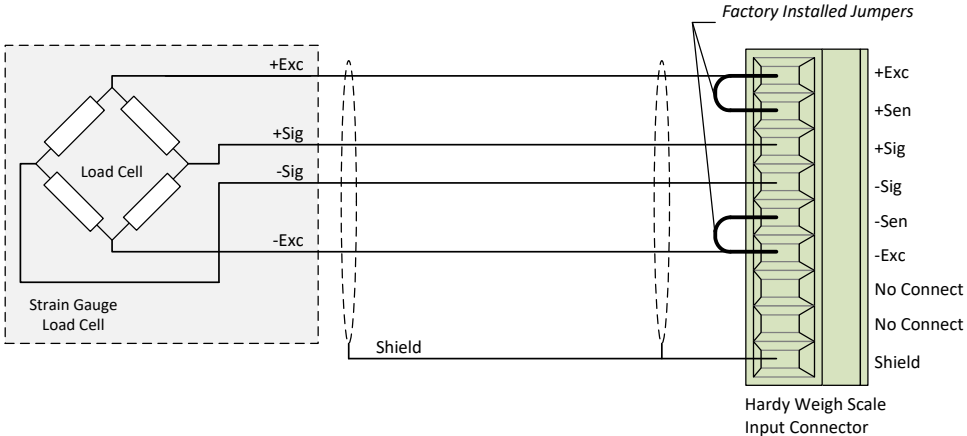

Non-C2 load sensor wiring

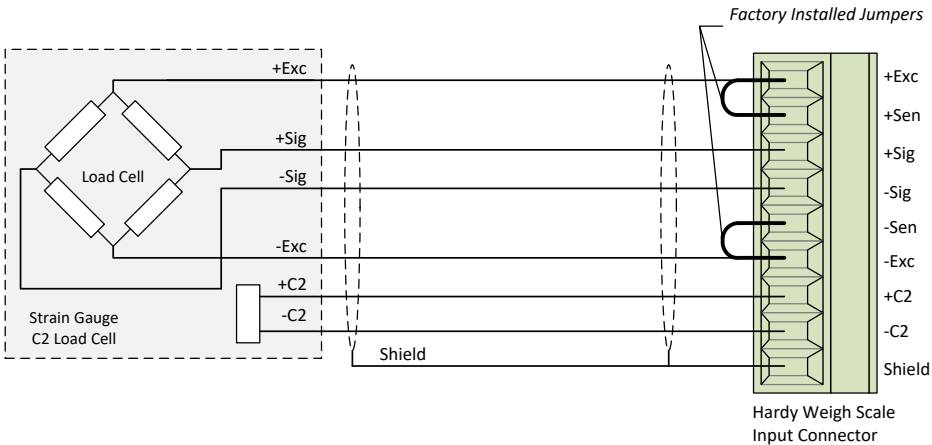

Hardy load sensor with C2 wiring

WARNING: To prevent ignition of flammable or combustible atmospheres, disconnect power before servicing

CAUTION: Observe precautions for electrostatic sensitive devices when handling the summing box terminal connections

Applicable Certification Documents for Intrinsically Safe Protection Techniques

Hazardous Location	Applicable Certification Document for intrinsic safety	
	USA	Canada
Class I Division 1	UL 913	CSA 157
Class II Division 1	UL 913	CSA 157

Standards used for evaluation of the HI 6020 summing box series:

- UL 913 STANDARD FOR INTRINSICALLY SAFE APPARATUS AND ASSOCIATED APPARATUS FOR USE IN CLASS I, II, III, DIVISION 1, HAZARDOUS (CLASSIFIED) LOCATIONS - Edition 8 - Revision Date 2015/04/28
- CSA C22.2 NO. 157-92 INTRINSICALLY SAFE AND NON-INCENDIVE EQUIPMENT FOR USE IN HAZARDOUS LOCATIONS - Edition 3 - Revision Date 2003/06/01
- ISA 12.12.01 NONINCENDIVE ELECTRICAL EQUIPMENT FOR USE IN CLASS I AND II, DIVISION 2, AND CLASS III, DIVISIONS 1 AND 2 HAZARDOUS (CLASSIFIED) LOCATIONS - Edition N/A - Issue Date 2013/06/03
- CSA C22.2 NO. 213-M1987 NON-INCENDIVE ELECTRICAL EQUIPMENT FOR USE IN CLASS I, DIVISION 2 HAZARDOUS LOCATIONS (1987 EDITION) - Edition 1 - Issue Date 1987/03/01

This page intentionally left blank

At Hardy, we believe that industrial weighing solutions should be EASY to engineer and operate.

We believe that simplicity delivers the LOWEST TOTAL COST to own.

That's why our solutions are EASIER to install, integrate, commission, diagnose and maintain.

Want MORE PRODUCTIVITY at the LEAST TOTAL COST to own? Call Hardy to discover how Today!



10075 Mesa Rim Road, San Diego, CA 92121
Telephone: 1-800-821-5831 FAX: (858) 278-6700
Web Address: <http://www.hardysolutions.com>

Hardy Process Solutions Document Number: 0596-0352-01 REV C
© Copyright 2014-2015, Hardy Process Solutions, All Rights Reserved.

Printed in the U.S.A.